

Three-phase motors Cast iron housing

Type		SC2 315LB4-695 AB
Design output	[kW]	200
Design torque	[Nm]	1285
Class IE		IE2-95.8%
Efficiency determination		EN 60034-2-1
Duty type		S1
Design frequency	[Hz]	50
Design speed	[rpm]	1485
Voltage	[V]	400/690
Connection		D / Y
Current	[A]	342.0 / 198.3
Relative pull-in current		6.0
Relative starting torque		2.2
Relative pull-out torque		3.0
Efficiency 100 / 75 / 50 %	[%]	95.8 / 95.4 / 95.1
Power factor		0.88
Th. cl.		155 (F/B)
Coolant temperature	[°C]	-20°C ... +40°C
Altitude above sea level	[m]	1000
Degree of protection IP		IP 55
Moment of inertia	[kgm ²]	4.47000
Motor weight	[kg]	1330
Bearing D-side		NU319E/C3
Bearing N-side		6319/C3
Relubrication interval	[h]	2200 / 4600
Grease type		ESSO BEACON 3 / SKF LGMT3
Grease amount	[g]	51
A-sound pressure level L _{WA}	[dB]	88.0

Options:

Terminal box	Standard
Position of terminal box	On the top
Cable gland	Brass cable glands
Position of cable entry	Right
Shaft	Standard
Bearing	Relubrication device, heavy bearing arrangement
Special information about the bearing	SKF bearing
Winding protection	1 set PTC resistors
Limit values to vibration velocity	Class A
Balancing	with half key
Colour	RAL 7030

Delivery conditions and/or official regulations	IEC / EN 60034-1
---	------------------

Data sheet

IM B3



IM B35

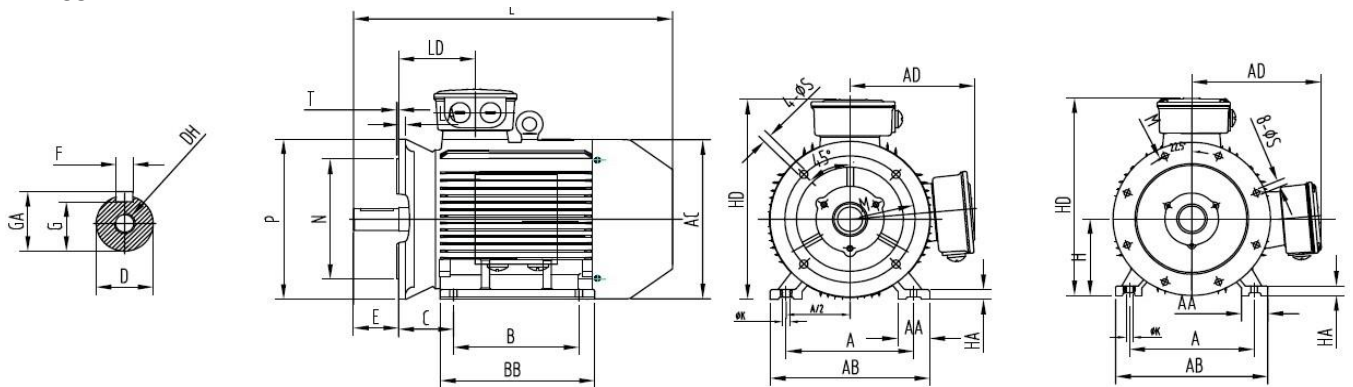

IM B5

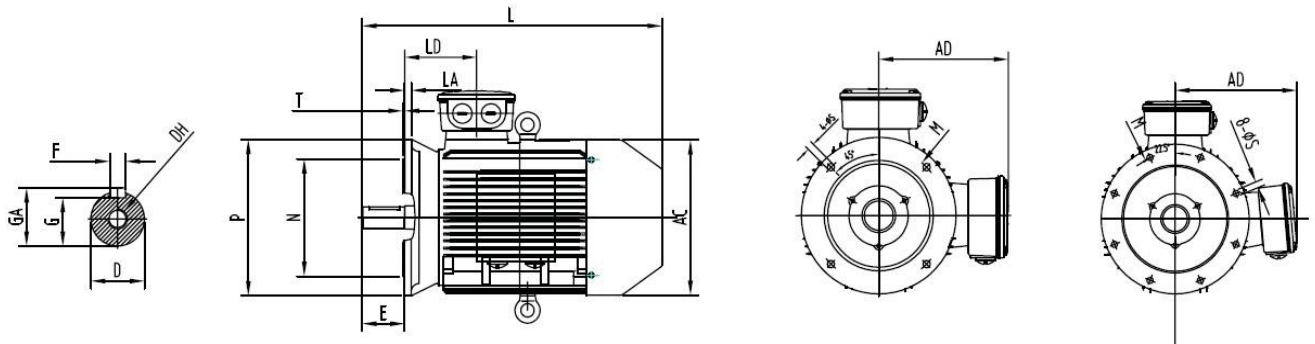

A	B	B ¹	C	D	E	F	G	H	K	DH	GA	AA	AB
508	457	508	216	80	170	22	71	315	28	M20x46	85	120	630

AC	AD	HA	HD	BB	LD	L	M	N	P	S	T	LA
645	535	45	885	680	257	1325	600	550	660	8 x ø24	6	22