

Three-phase motors Aluminium housing

Type		SA2 112M4-695 AA
Design output	[kW]	4.0
Design torque	[Nm]	26.5
Class IE		IE2-86.6%
Efficiency determination		EN 60034-2-1
Duty type		S1
Design frequency	[Hz]	50
Design speed	[rpm]	1440
Voltage	[V]	400/690
Connection		D / Y
Current	[A]	8.2 / 4.8
Relative pull-in current		7.5
Relative starting torque		2.6
Relative pull-out torque		2.9
Efficiency 100 / 75 / 50 %	[%]	86.6 / 85.9 / 82.1
Power factor		0.81
Th. cl.		155 (F/B)
Coolant temperature	[°C]	-20°C ... +40°C
Altitude above sea level	[m]	1000
Degree of protection IP		IP 55
Moment of inertia	[kgm ²]	0.01176
Motor weight	[kg]	32.0
Bearing D-side		6306 2RS/C3
Bearing N-side		6306 2RS/C3
Relubrication interval	[h]	-
Grease type		-
Grease amount	[g]	-
A-sound pressure level L _{WA}	[dB]	74.0
Options:		
Terminal box		Standard
Position of terminal box		On the top
Cable gland		Brass cable glands
Position of cable entry		Right
Shaft		Standard
Bearing		Easy bearing arrangement
Special information about the bearing		SKF bearing
Winding protection		-
Limit values to vibration velocity		Class A
Balancing		with half key
Colour		RAL 7030
Delivery conditions and/or official regulations		IEC / EN 60034-1

Data sheet

IM B3

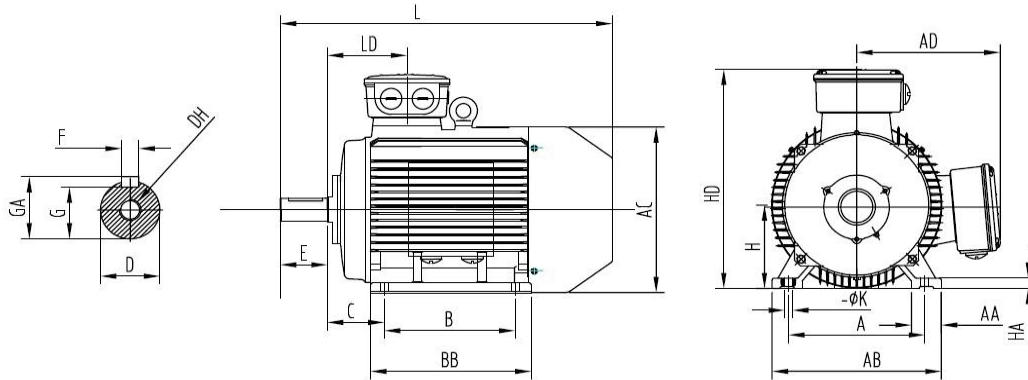

IM B35

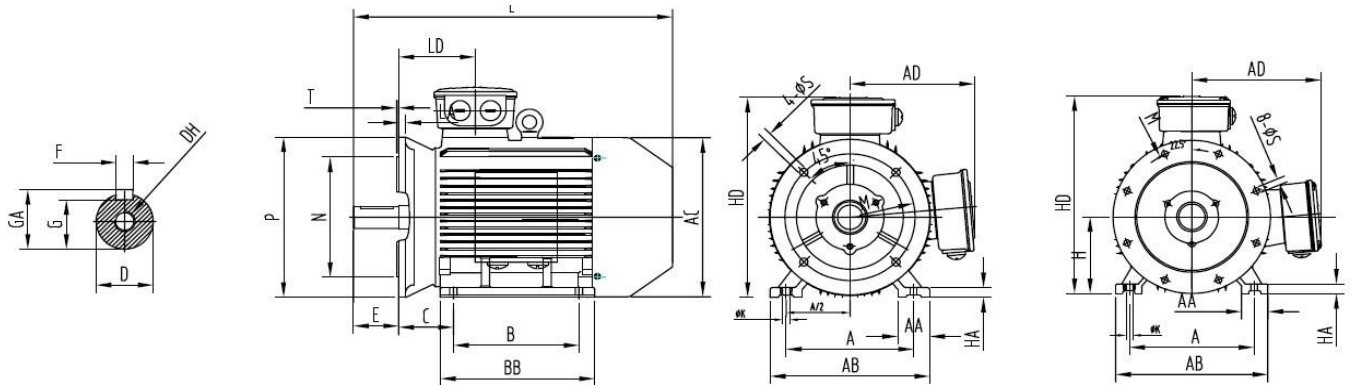

IM B5

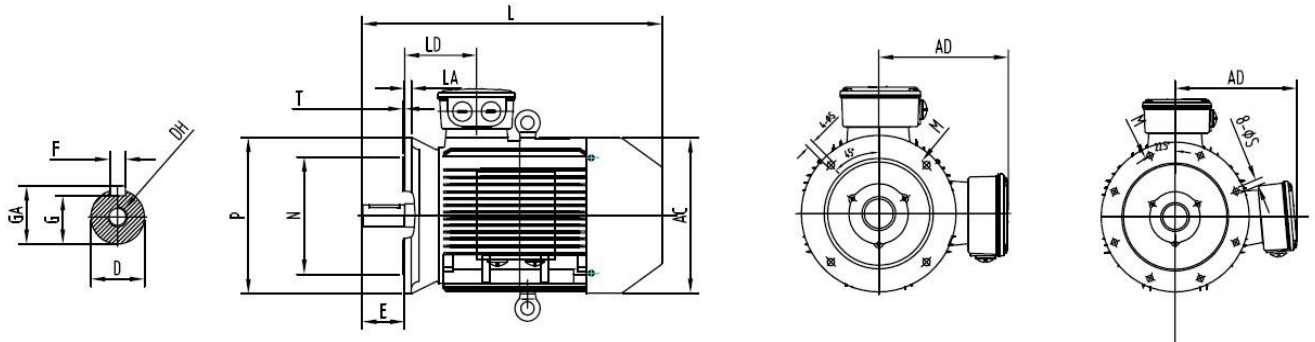

A	B	B ¹	C	D	E	F	G	H	K	DH	GA	AA	AB
190	140	-	70	28	60	8	24	112	12	M10x22	31	55	220

AC	AD	HA	HD	BB	LD	L	M	N	P	S	T	LA
221	179	14	291	180	88	394.5	215	180	250	4 x ø14.5	4	-

Data sheet

IM B14

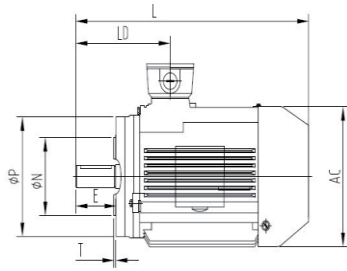

IM B34

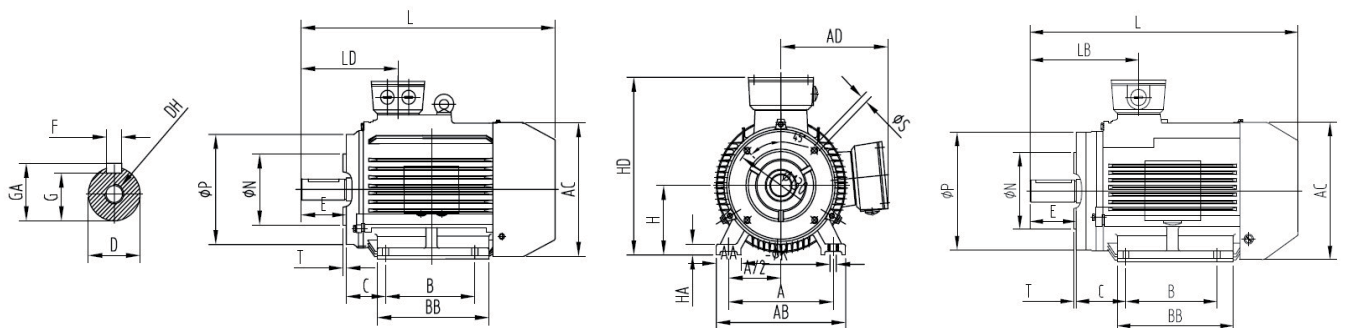

A	B	B ¹	C	D	E	F	G	H	K	DH	GA	AA	AB
190	140	-	70	28	60	8	24	112	12	M10x22	31	55	220

	AC	AD	HA	HD	BB	LD	L	M	N	P	S	T	LA
B14C	221	179	14	291	180	88	394.5	130	110	160	4 x M8	3.5	-
B14B	221	179	14	291	180	88	394.5	165	130	200	4 x M10	3.5	-