

Three-phase motors Aluminium housing

Type		SA2 80A2-405 AA
Design output	[kW]	0.75
Design torque	[Nm]	2.53
Class IE		IE2-77.4%
Efficiency determination		EN 60034-2-1
Duty type		S1
Design frequency	[Hz]	50
Design speed	[rpm]	2830
Voltage	[V]	230/400
Connection		D / Y
Current	[A]	3.0 / 1.7
Relative pull-in current		6.8
Relative starting torque		3.0
Relative pull-out torque		3.2
Efficiency 100 / 75 / 50 %	[%]	77.4 / 77.1 / 76.4
Power factor		0.82
Th. cl.		155 (F/B)
Coolant temperature	[°C]	-20°C ... +40°C
Altitude above sea level	[m]	1000
Degree of protection IP		IP 55
Moment of inertia	[kgm ²]	0.00085
Motor weight	[kg]	9.0
Bearing D-side		6204 2RS/C3
Bearing N-side		6204 2RS/C3
Relubrication interval	[h]	-
Grease type		-
Grease amount	[g]	-
A-sound pressure level L _{WA}	[dB]	76.0
Options:		
Terminal box		Standard
Position of terminal box		On the top
Cable gland		Brass cable glands
Position of cable entry		Right
Shaft		Standard
Bearing		Easy bearing arrangement
Special information about the bearing		SKF bearing
Winding protection		-
Limit values to vibration velocity		Class A
Balancing		with half key
Colour		RAL 7030
Delivery conditions and/or official regulations		IEC / EN 60034-1

Data sheet

IM B3



IM B35

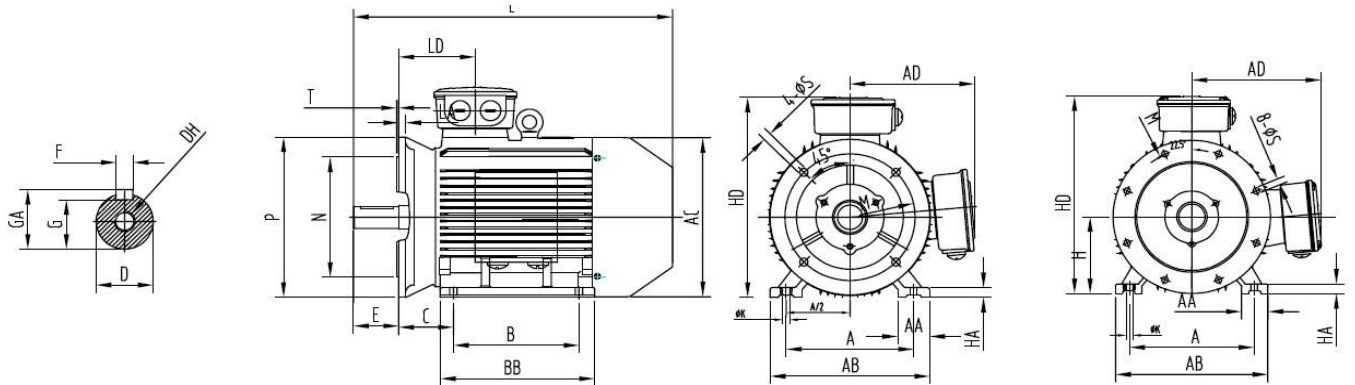

IM B5

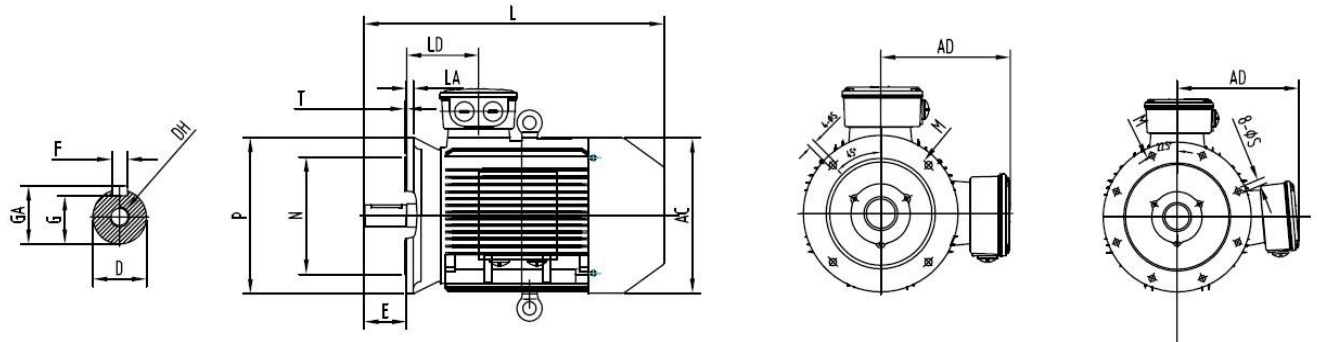

A	B	B ¹	C	D	E	F	G	H	K	DH	GA	AA	AB
125	100	-	50	19	40	6	15.5	80	10	M6x19	21.5	41	160

AC	AD	HA	HD	BB	LD	L	M	N	P	S	T	LA
156	137	10	217	130	80	290	165	130	200	4 x Ø12	3.5	-

Data sheet

IM B14



IM B34



A	B	B ¹	C	D	E	F	G	H	K	DH	GA	AA	AB
125	100	-	50	19	40	6	15.5	80	10	M6x19	21.5	41	160

	AC	AD	HA	HD	BB	LD	L	M	N	P	S	T	LA
B14C	156	137	10	217	130	80	290	100	80	120	4 x M6	3	-
B14B	156	137	10	217	130	80	290	130	110	160	4 x M8	3.5	-